

WATERbearing

FIREPLACE & STOVE INSERTS



BRUNNER[®]

heizen auf bayerisch.



Hubertus Brunner & Ulrich Brunner

heizen auf bayerisch.

BRUNNER was one of the first manufacturers offering proven wood-fired inserts for handcrafted stoves as water-bearing devices. In addition to the usual heating effect of a fireplace or a tiled stove, part of the available heat is supplied into the central heating system.

BRUNNER's decades of experience evolved into the most diverse applications of such constructions. Our partner craftsmen got acquainted with the design and limits of applications during numerous training sessions. This means safety for our valued customers, who want to take care of their fundamental need of warmth.

All waterbearing inserts are approved for use as individual fireplaces and comply with the requirements of the amended 1st Federal Immission Control Regulation (BImSchV) in Germany, the ECO-Design regulations of the European Union and the applicable laws in Switzerland.



Hubertus Brunner

CONTENTS

The next winter is sure to come.	4
A tiled stove can do more.	6
How to get heat from wood and into the radiators?	8
More useful than ever.	11
The evaluations of lawmakers	12
Water-bearing fireplaces.	16
Water-bearing tiled stoves.	24
Comfort of use: the electronic control system.	42
The planning.	44
Safety.	46
Hydraulic connection.	49
The BRUNNER Heating Center.	50
Heat pump & stove integration	54
The variants.	56

THE NEXT *winter* *is sure* TO COME.

There is probably nothing more beautiful and useful at the same time, than taking care of your home heating with a fireplace or tiled stove.

As support for your existing heating system or inbetween seasons - it is always fun to provide for heating with your domestic energy resources. This comes with a feeling of security and certainty, which derives from the ability to take care for the fundamental needs of your family.

To find the right design approach and solution, it requires extensive specialist knowledge.

The **BRUNNER** partner craftsmen will be very glad to help you with this.



BRUNNER
partner craftsman search



Water-bearing fireplace
Architektur-Kamin 45/101
with top-mount boiler

A *tiled stove* can do more

THE WATER-BEARING FIREPLACE/STOVE INSERT AS SUPPORT FOR YOUR HEATING SYSTEM.

HEAT GENERATORS

SOLAR



Solar thermal panels
1)



Photovoltaics

WOOD



Water-bearing stove/
fireplace



Wood heating system



AIR



Air-water heat pump (monoblock)

OIL/GAS



Fossil energy

THE BRUNNER HEATING CENTER. A SOPHISTICATED HEATING SYSTEM, COMBINING VARIOUS HEATING DEVICES WITH GUARANTEED FUNCTIONALITY.

HEAT STORAGE AND DISTRIBUTION

HEAT CONSUMERS



HEATING

Radiators, floor heating, wall heating, swimming pool ...



HEATING CENTER & STORAGE SYSTEM

HOT WATER



Fresh water module, hot water tank

¹⁾ Solar thermal panels cannot be combined with a BRUNNER heat pump

HOW TO GET

heat FROM WOOD

AND INTO THE RADIATORS?

Heat is released during a combustion process. The combustion chamber walls are getting extremely hot, and the temperature of combustion gases is likely to reach 600-800 degrees Celsius. Depending on application, each or both of these effects of combustion can be used for heating water production.

When the hot combustion chamber walls are surrounded by a water jacket, they will heat up the metallic enclosure of the boiler and the water inside.

Even more heat can be derived from the hot combustion gases. After combustion chamber they can be led through a metallic water-filled heat exchanger. This is the most effective way of transferring heat of combustion gases into water.

The water-filled boiler case and the heat exchanger are working together. Both devices raise the temperature of water up to 70 - 80 °C, which in turn is collected in a storage tank to supply on demand: radiators, floor heating and wall panel heating.

The heating inside the room, where the boiler is installed, is provided during combustion via heat radiation through the glass door of combustion chamber. In case of water-bearing wood combustion inserts, the combustion gases directly or the residual heat behind the water-filled heat exchanger are used to heat up a storage mass. After combustion ends, the stored heat is returned via stove cladding as pleasant radiant heat.

To find out where the heating power comes from, please refer to page 44.

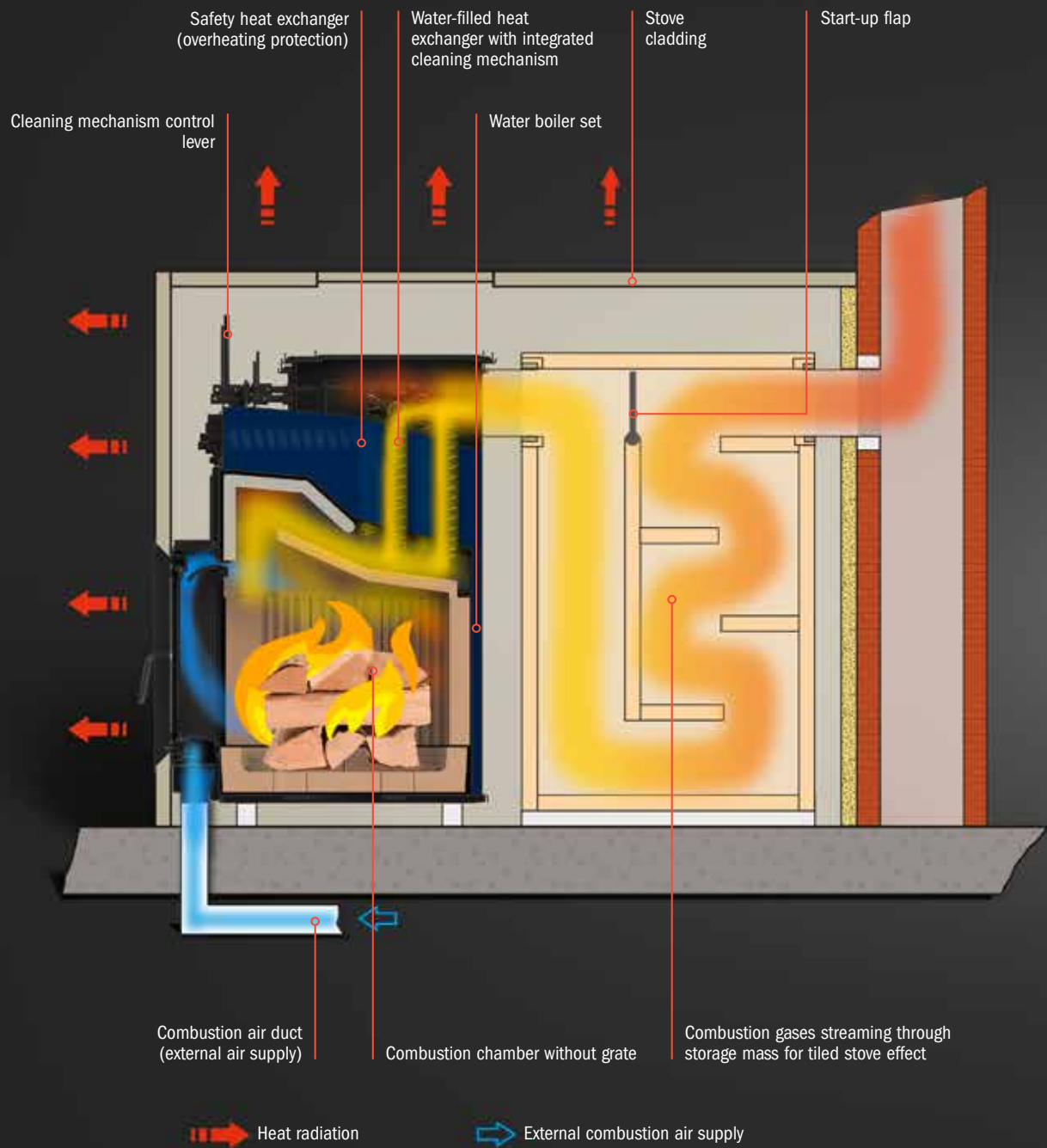

**WATER-BEARING WOOD COMBUSTION INSERT
WITH A CERAMIC STORAGE MASS (KOMPAKT-KESSEL B4)**



Water-bearing tiled stove:
The "living-room boiler" HKD 2.2 XL-SK/h Tunnel

WATERBEARING FIREPLACES AND TILED STOVES
ARE NOWADAYS MUCH

more useful **THAN EVER**

The energy standard of family homes with a heating demand of approx. 4 - 7 kW makes water-bearing wood combustion devices a true alternative for the heat supply of many families. From late summer to early spring it is sufficient to burn one or two loads of wood per day to ensure hot water and heating supply without the need to activate the main heating system. Even during "emergency periods", the total heat demand can be covered by a water-bearing fireplace or tiled stove.

A perfect combination is the BRUNNER heat pump with a water-bearing wood stove system, for example. At lowest outdoor temperatures, when the air-water heat pump is not so efficient, nothing could be more reasonable as to use the wood stove for relief. Especially during frosty days, higher water temperatures are required for the heating circuits. The fireplace or tiled stove boiler will do the job!

For comfortable use of such "hybrid heating systems" we recommend BRUNNER solutions with a buffer tank and a perfect hydraulic installation (e.g. BRUNNER Heating Center BHZ). A modern heating system cannot be more controllable and easy to operate.

But what happens during a power failure? With a BRUNNER uninterruptible power supply all necessary heating pumps and the control system remains operational.

Good to know that such solutions are available today.

THE *evaluations* OF LAWMAKERS

The novelized and currently valid 1.BImSchV (German immision control law) provides emission limits not only for individual fires, but also for heating with water-bearing fireplaces and wood burners.



THE FOLLOWING MUST BE TAKEN INTO ACCOUNT:

- If a water-bearing fireplace or tiled stove is installed as the only heating system, it is considered as central heating and not as individual firing appliance. As a consequence, a periodic measurement performed by a chimney sweep is required.
- When a water-bearing fireplace or tiled stove is installed for heating support, it is classified as additional heating. In this case there are no requirements for initial or periodic measurement to be performed by chimney sweeps. The operating permit for water-bearing individual fires is issued under condition that a proof of type testing is present.
- The rated power of individual fires must correspond to the heat demand of the place of installation.

CONCLUSION:

In all European countries except Germany, water-bearing wood fires are appreciated as heating solutions with reduced CO₂ emissions and sometimes strongly subsidised. In Germany, the rule is that water-bearing fireplaces and tiled stoves are installed as second-tier heating devices. It means, that a classic heat source like gas heater, heat pump or electric heating is present and in operation together with a water-bearing individual fire. For combinations with larger thermal or photovoltaic solar systems, special calculation proofs are required in order to classify them as "main heating systems". The user's behaviour in general is not considered by the lawmakers.

The rules mentioned above are valid only for new installations, not for existing water-bearing fireplaces and tiled stoves.

As part of the initial inspection, the chimney sweep will check if the guidelines are followed. Therefore, we recommend to discuss the building project with the chimney sweep in advance, because there are different guidelines for interpretation of the 1.BImSchV regulations in different regions.

INDIVIDUAL HEATING SYSTEMS WITH WATER-BEARING WOOD COMBUSTION DEVICES ARE DESIGNED AND BUILT BY SPECIALIZED STOVE BUILDING COMPANIES AND INTEGRATED WITH THE HYDRAULIC SYSTEM BY A HEATING ENGINEER.



BRUNNER heat pump combined with a water-bearing tiled stove
The "living-room boiler" HKD 2.2 XL-SK/h Tunnel with side-opening door

WATER-BEARING TILED STOVE...



Water-bearing tiled stove
The "living-room boiler" HKD 7 SK Tunnel
Design: Ofenbau Grabowski

... OR WATER-BEARING FIREPLACE.



Water-bearing fireplace
Kamin-Kessel Eck 45/67/44 I
Custom-made mounting frame

WATER-BEARING *fireplace* OR *tiled stove*?

A simple decision in itself, which is made according to personal preferences and desires, and should be taken already at the beginning.

- **Water-bearing fireplaces with big glass pane = *fireplace atmosphere***
- **Water-bearing tiled stoves with heat storage mass = *tiled stove effect***

As soon as the answer is clear, the type of heating device is selected in the second step. Here the heat demand of the building and the size of the room for installation are important criteria (chapter Planning, page 44). The variety of water-bearing heating devices offered by BRUNNER takes into account that the desired solution can be found with a suitable fireplace or tiled stove.



**BRUNNER WATER-BEARING FIREPLACE AND TILED STOVE
INSERTS ARE AMONG THE BEST THAT CAN BE OFFERED BY
THE STOVE BUILDING CRAFT.**



WATER-BEARING *fireplaces*

Water-bearing fireplace inserts are offered with different glass and combustion chamber dimensions. The sight glass offers fireside atmosphere and provides heating inside the room during combustion.

The types of boiler and heat exchanger determine the water heating share available for heating support. When fire burns frequently, a powerful boiler can avoid the "steam bath" effect in the place of installation.

It is the art of a stove building master, to select the right option for the desired application in accordance with the customer's wishes.

The "Kamin-Kessel" principle
water-bearing fireplace with powerful boiler, Kamin-Kessel Eck 45/67/44

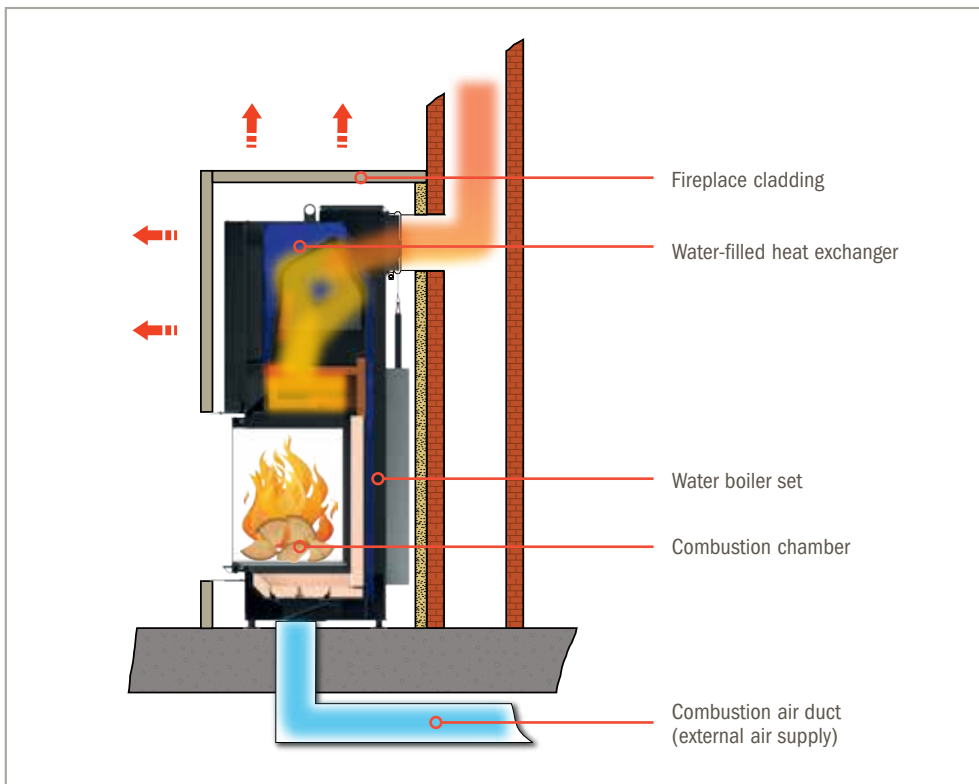

FIREPLACE WITH POWERFUL *boiler*

A BOILER CASE WITH INTEGRATED HEAT EXCHANGER IS THE MOST POWERFUL WATER HEATING SOLUTION. WITH LARGE GLASS PANES MORE POWER IS NOT POSSIBLE!

Heating in the place of installation is provided directly via heat radiation through the glass door of combustion chamber. Corner variants are installed in more spacious living areas.



Kamin-Kessel
Eck 42/57/30 I

Wood capacity: 3 - 8 kg
Log length: 33 - 50 cm



Kamin-Kessel
Eck 45/67/44 I

Wood capacity: 3 - 8 kg
Log length: 33 - 50 cm

Left/right corner variants available

The Kamin-Kessel boilers combine the atmosphere of a true fireplace with maximal water heating capabilities for heating support.

Allocation of available heat

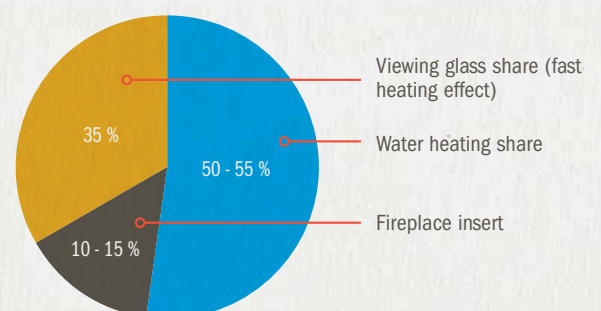

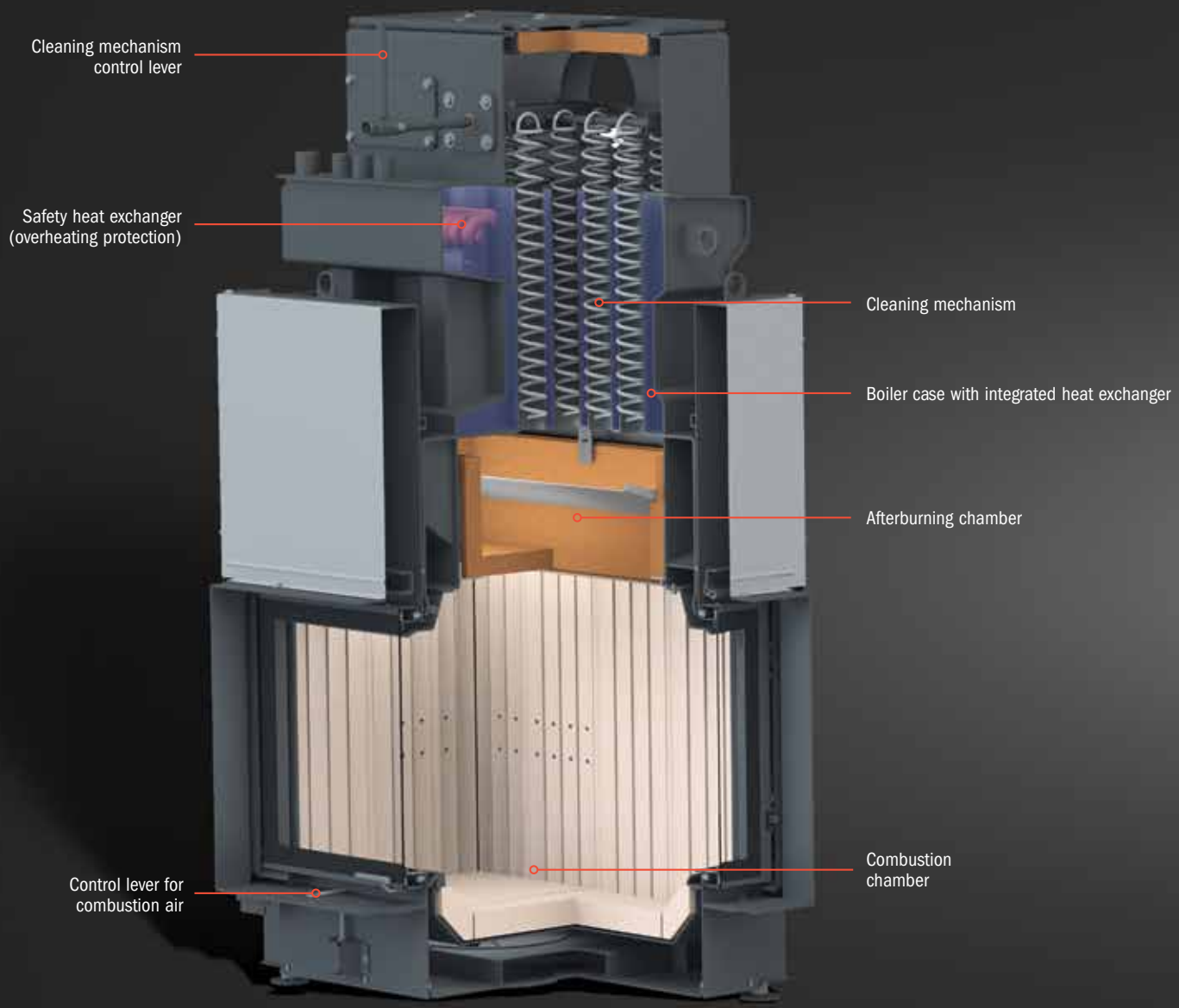

WATER-BEARING FIREPLACE
KAMIN-KESSEL ECK 45/67/44 L

FIREPLACES WITH *top-mount boiler*

FIREPLACES WITH TOP-MOUNT BOILER GIVE AWAY MORE HEAT INTO THE ROOM.



Architektur-Kamin 38/86
with top-mount boiler

Wood capacity: 4 - 7 kg
Log length: 33 - 50 cm



Architektur-Kamin 45/101
with top-mount boiler

Wood capacity: 4 - 7 kg
Log length: 33 - 50 cm



Stil-Kamin 51/67
with top-mount boiler

Wood capacity: 4 - 7 kg
Log length: 33 - 50 cm

Instead of a metallic reheater, on top of the fireplace there is a boiler with integrated fin-type heat exchanger. The ribbed structure significantly increases the heat-exchanging surface. This allows for more compact fireplaces with reduced height. During normal operation, deposits on fins are mostly burnt out due to high surface temperatures.

Allocation of available heat

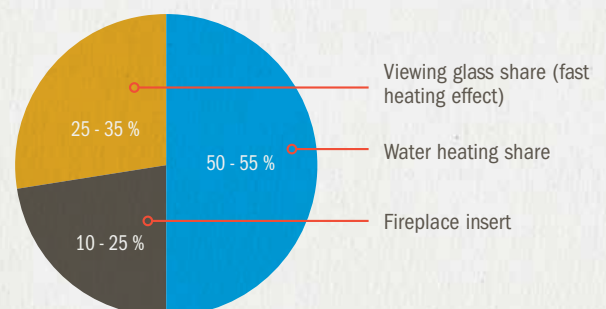

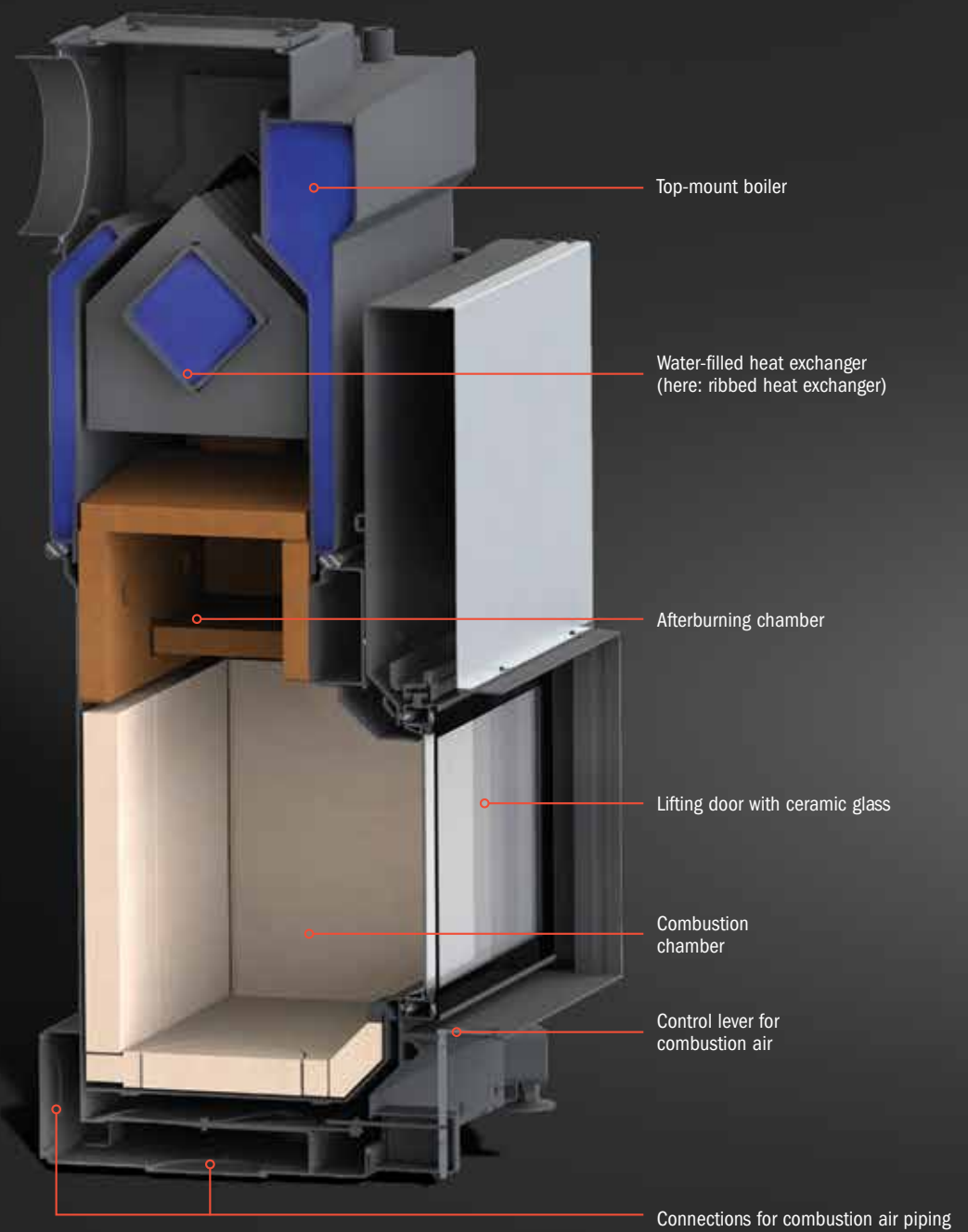

ARCHITEKTUR-KAMIN 38/86
WITH TOP-MOUNT BOILER

FIREPLACES WITH *double view*

WATER-BEARING FIREPLACES WITH TWO GLASS DOORS. THE PERFECT ROOM DIVIDER.

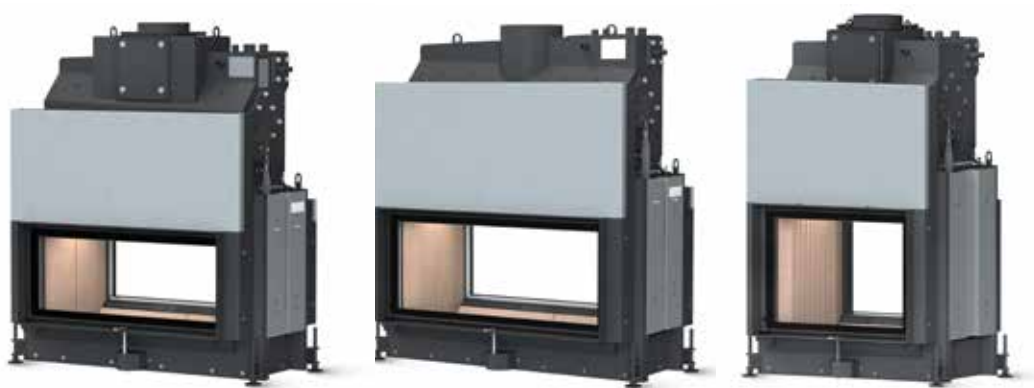

Architektur-Kamin
Tunnel 38/86
with top-mount boiler

Wood capacity: 4 - 7 kg
Log length: 33 - 50 cm

Architektur-Kamin
Tunnel 45/101
with top-mount boiler

Wood capacity: 4 - 7 kg
Log length: 33 - 50 cm

Stil-Kamin Tunnel 51/67
with top-mount boiler

Wood capacity: 4 - 7 kg
Log length: 33 - 50 cm

The free view of fire from both sides increases the direct heat radiation during combustion. In case of frequent use and in small living rooms, doors with double glazing are applied.

Combustion air adjustment is possible on both sides. A side-opening or tilting door is present on one side.

Allocation of available heat

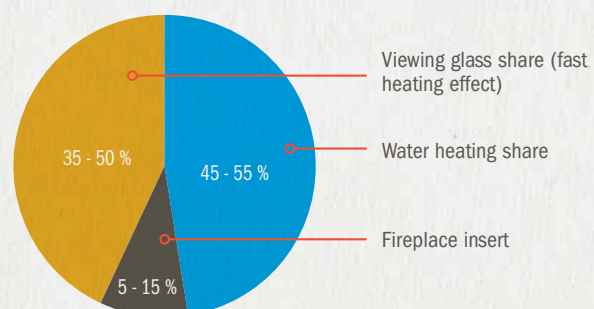

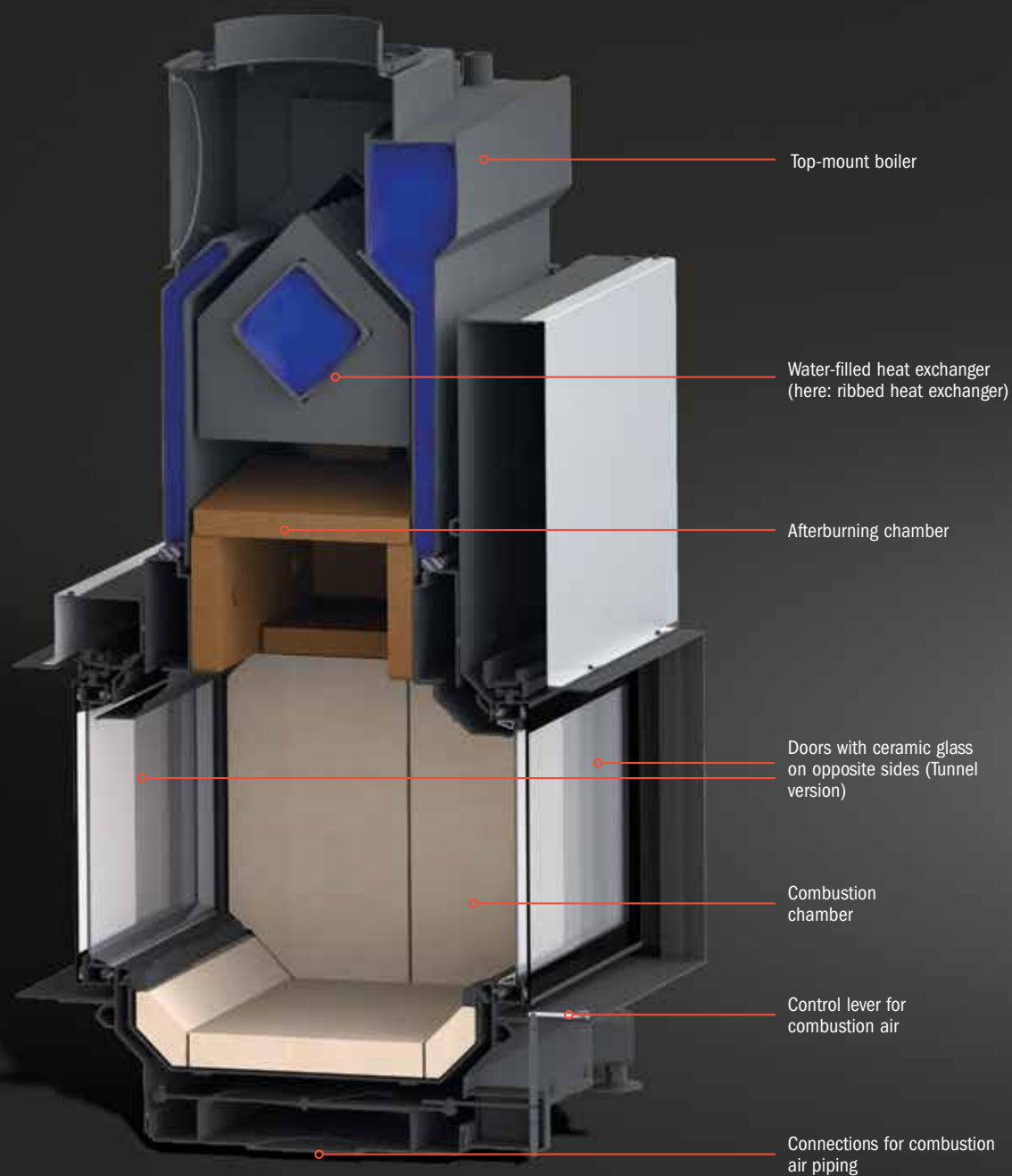

ARCHITEKTUR-KAMIN TUNNEL 38/86
WITH TOP-MOUNT BOILER



Water-bearing tiled stove
The "living-room-boiler" HKD 7 SK Tunnel

WATER-BEARING *tiled* *stoves*

THE WATER-BEARING TILED STOVE PROVIDES PLEASANT RADIANT HEAT IN THE PLACE OF INSTALLATION AND SUPPORTS THE HEATING SYSTEM INSIDE THE BUILDING.

The stove builder selects the suitable concept in terms of combustion chamber size (load of wood = heating power), visual appearance (glass dimensions) and heat distribution (boiler share and tiled stove effect).

More affordable heating concepts utilize water-bearing stoves with fixed boiler share (e.g. Kompakt-Kessel).

SUITABLE WATER-BEARING TILED STOVES FOR EVERY BUILDING AND HEATING SITUATION:

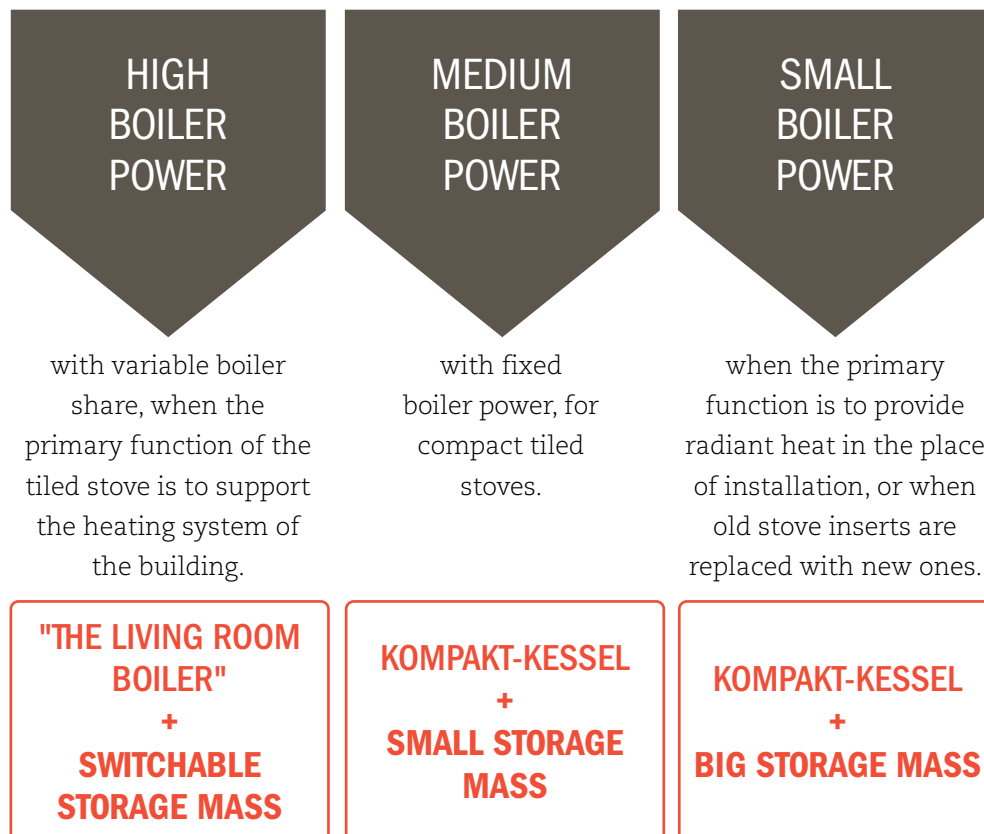

TILED STOVES WITH POWERFUL BOILER

THE *living room boilers*

THE MOST POPULAR VARIANTS.

The "Stubenkessel" (short: "SK") or "living room boiler" types are offered since 1996. The "SK" is the most popular boiler type, which is installed when wood combustion is expected to contribute a lot to water heating.

"LIVING ROOM BOILERS" ARE OFFERED IN VARIOUS CONSTRUCTION TYPES AND COMBUSTION CHAMBER SIZES



HKD 2.2k SK

Log length: 25 - 33 cm

HKD 2.2 SK

Log length: 33 cm

HKD 2.2 XL-SK/h

Log length: 50 cm

HKD 7 SK

Log length: 33 - 50 cm



water-bearing tiled stove
The "living-room boiler" HKD 2.2 XL-SK/h Tunnel
Design: Ofenbau Schulz

Principle OF "SK" BOILERS

HIGH BOILER POWER WITH TILED STOVE EFFECT ON DEMAND.

Using a switching valve (the Moritz's flap) installed before chimney entry it is possible to direct the stream of combustion gases from the firebox into the water-filled heat exchanger, or through a ceramic storage mass. With this simple trick it is easy to determine the share or distribution of heat.

If only water for heating purposes and a compact stove design are desired, the "SK" boilers with cleaning mechanism are connected directly to the chimney.

The immediate heat output into the room is through the sight glass. After combustion ends, the stored heat is returned via stove cladding as pleasant radiant heat.

VARIABLE

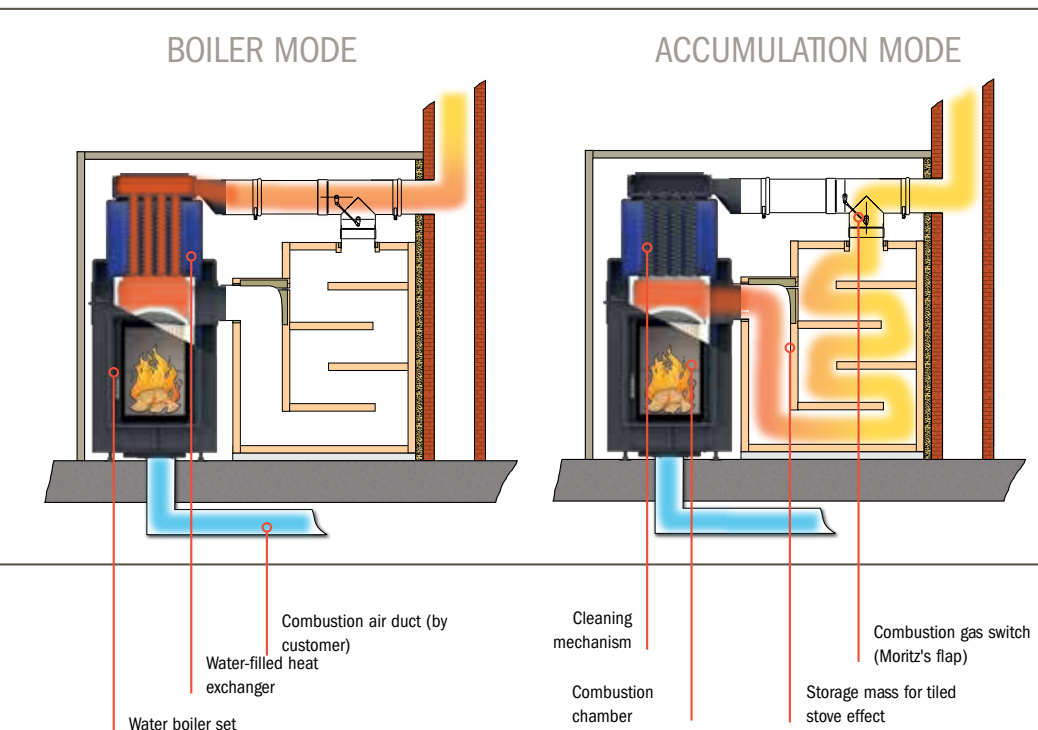

In boiler mode, water heating and buffer tank supply are main priorities.

In accumulation mode, ceramic storage mass heating prevails (radiant heat).

SPACE-SAVING

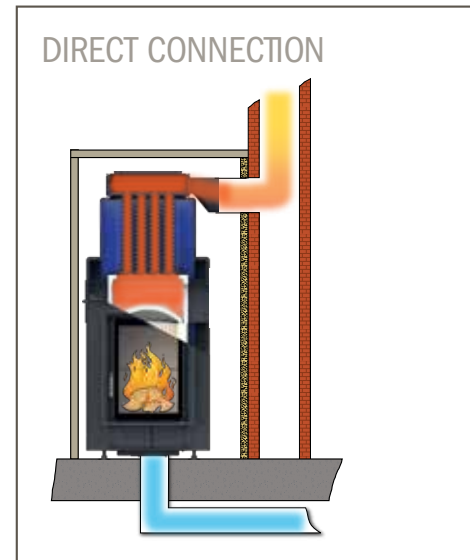

With direct connection only hot water for heating is provided. The heat projected from the firebox through the sight glass provides heating in the place of installation.



water-bearing tiled stove
The "living-room boiler" HKD 2.2 XL-SK/h
Design: Rogmans

THE LIVING ROOM BOILER

vertical FORMAT

The slim form of SK boiler with big sight glass and two variants of combustion chamber for 33 cm or 50 cm logs. The integrated cleaning mechanism allows for effortless heat exchanger cleaning.

If the stove is planned as a room-dividing structure, the "living room boiler" can be installed also as a Tunnel variant with a view of fire from both sides.



HKD 2.2 SK

Wood capacity:
Log length: 33 cm

for tiled stoves with storage mass up to: 450 kg

HKD 2.2 SK TUNNEL

3-8 kg

HKD 2.2 XL-SK/h

Wood capacity:
Log length: 50 cm

for tiled stoves with storage mass up to: 450 kg
*) air distribution setting for accumulation mode

HKD 2.2 XL-SK/h TUNNEL

3-8 kg /10-20 kg*

Allocation of available heat

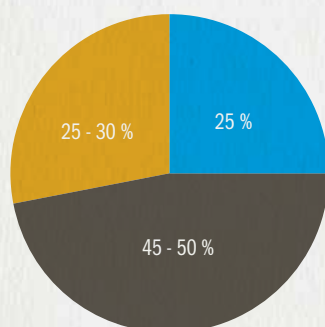

ACCUMULATION MODE

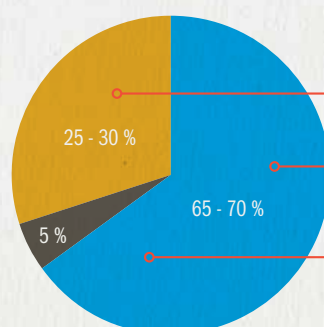

BOILER MODE

Sight glass share (fast heating effect)

Water heating share

Fireplace insert

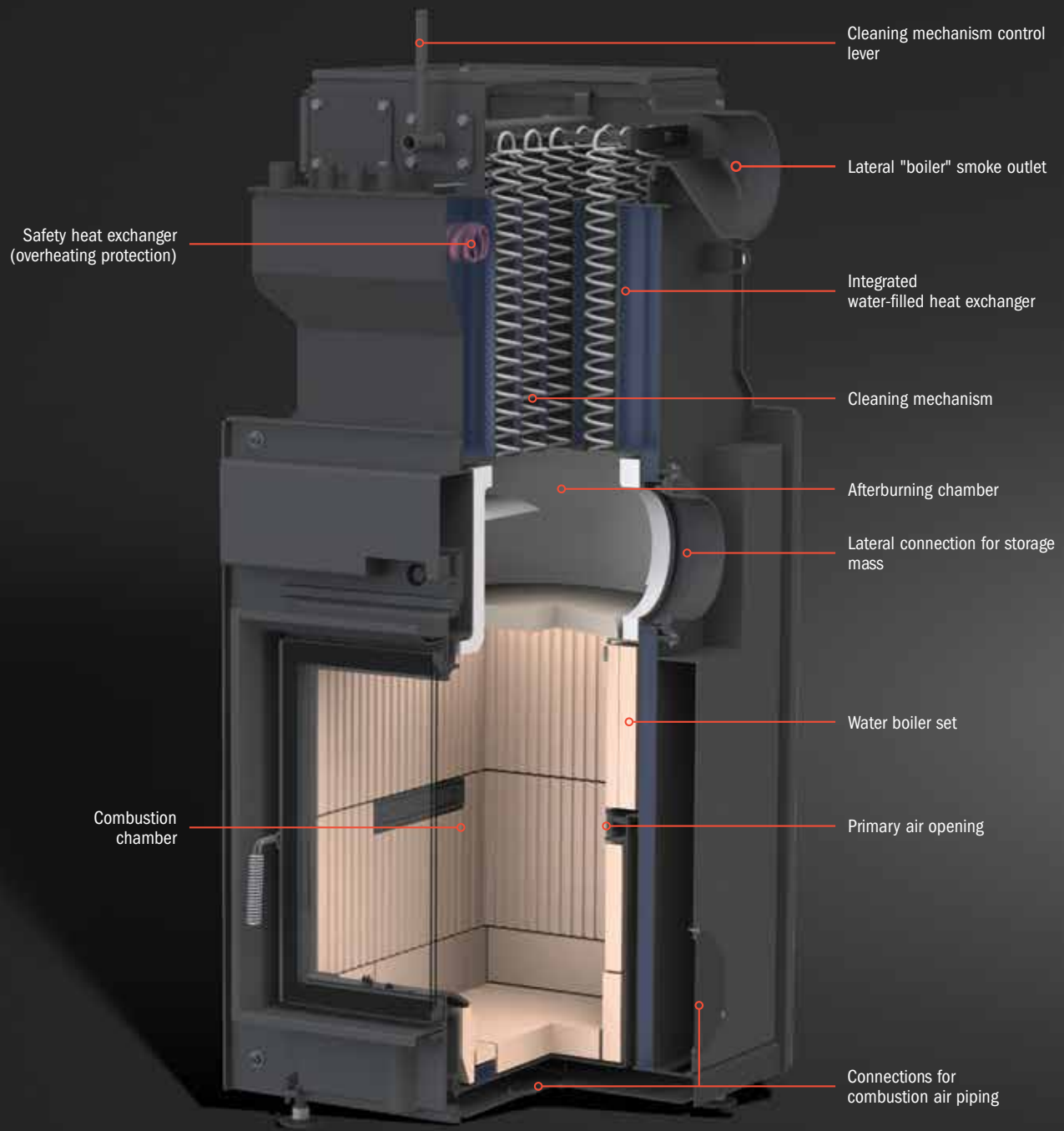

**THE LIVING ROOM BOILER
HKD 2.2 SK**

THE "SK" BOILER WITH *horizontal* FORMAT

- ▷ The horizontal format of "living room boiler".
- ▷ The reliable "heating machine" for 50 cm logs with integrated cleaning mechanism.
- ▷ As room divider with two sight glasses, with storage mass for more intense tiled stove effect - almost everything is possible!



HKD 7 SK

Wood capacity: 3 - 8 kg
Log length: 50 cm



HKD 7 SK Tunnel

Wood capacity: 10 - 20 kg
Log length: 50 cm

for tiled stoves with storage mass up to: 450 kg

Allocation of available heat

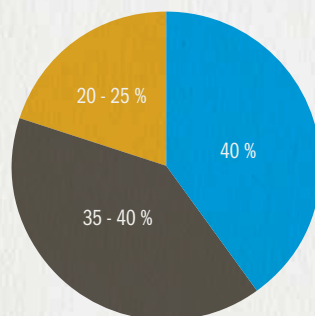

ACCUMULATION MODE

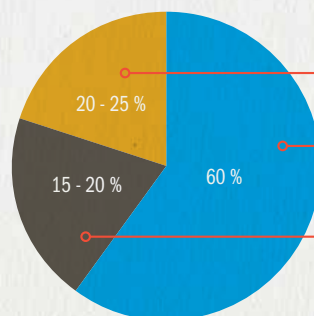

BOILER MODE

Sight glass share (fast heating effect)

Water heating share

Heating insert + reheating surface (retarded heating share)

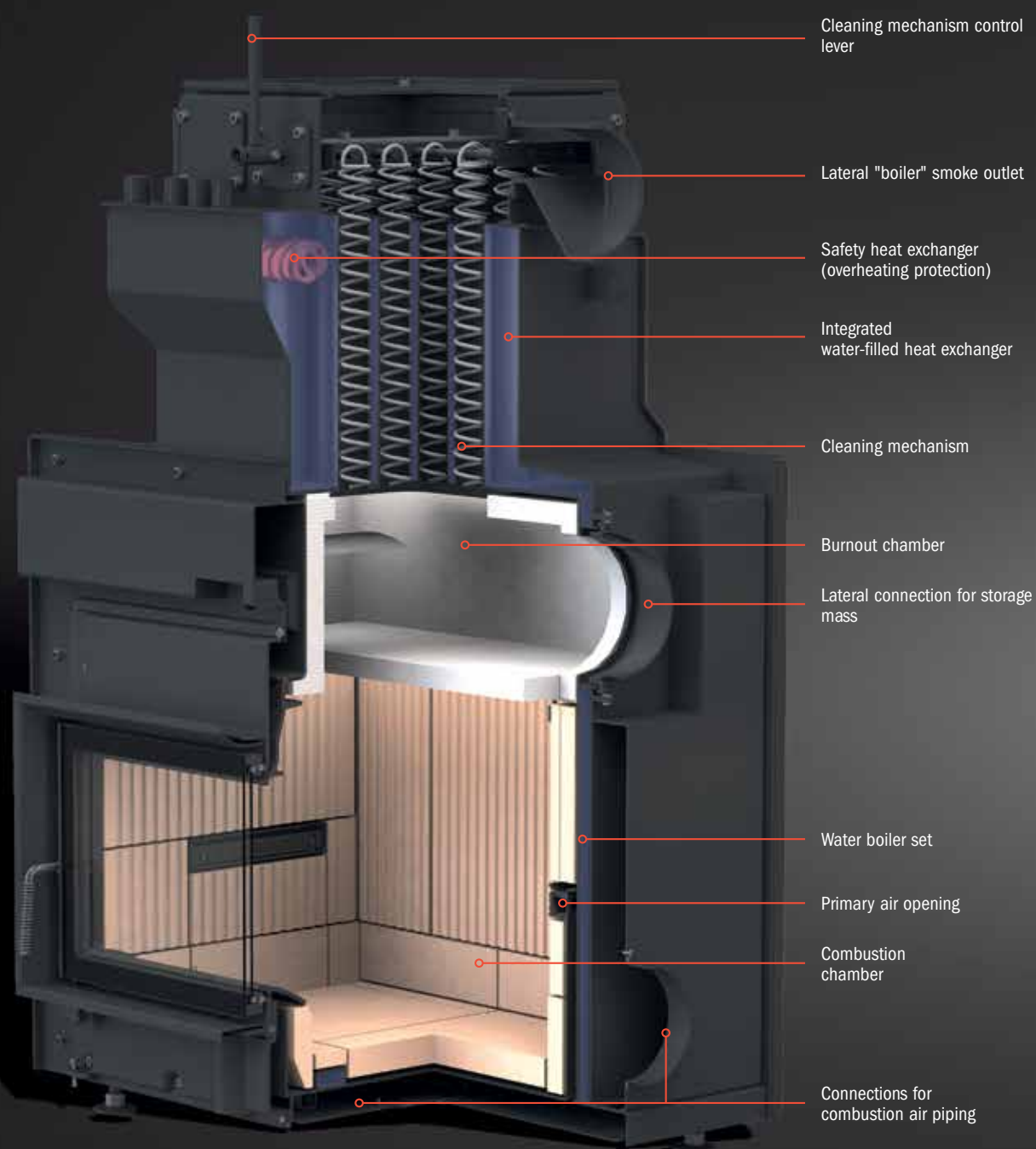

THE LIVING ROOM BOILER
HKD 7 SK

THE LIVING ROOM BOILER FOR *small* ROOMS

The design of HKD 2.2k SK with integrated fin-type heat exchanger allows for compact stove dimensions. Without any additional reheating devices, with direct chimney connection, it will find enough space in every room. The allocation of available heat is fixed, with a water heating share of approx. 70%. The size and type of sight glass determines the heat output into the room.

The cleaning of heat exchanger fins takes place through the combustion chamber.



HKD 2.2k SK flat

Wood capacity:
3 - 5 kg
Log length: 25 - 33 cm



HKD 2.2k SK round

Wood capacity:
3 - 5 kg
Log length: 25 - 33 cm



HKD 2.6k SK

Wood capacity:
3 - 5 kg
Log length: 25 - 33 cm

Allocation of available heat

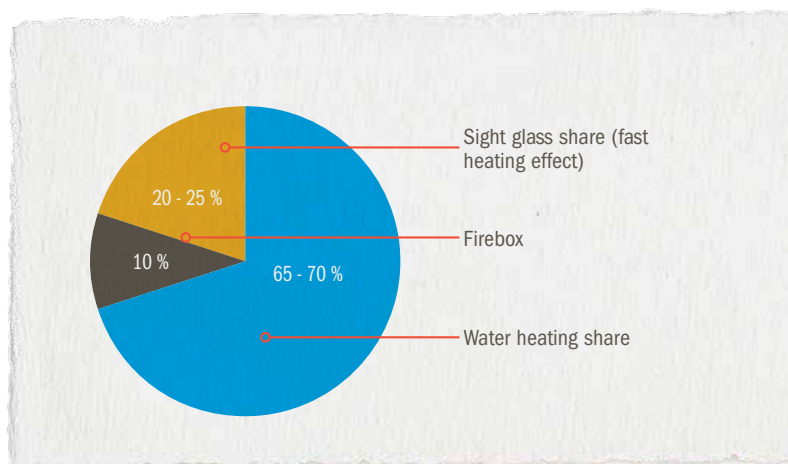

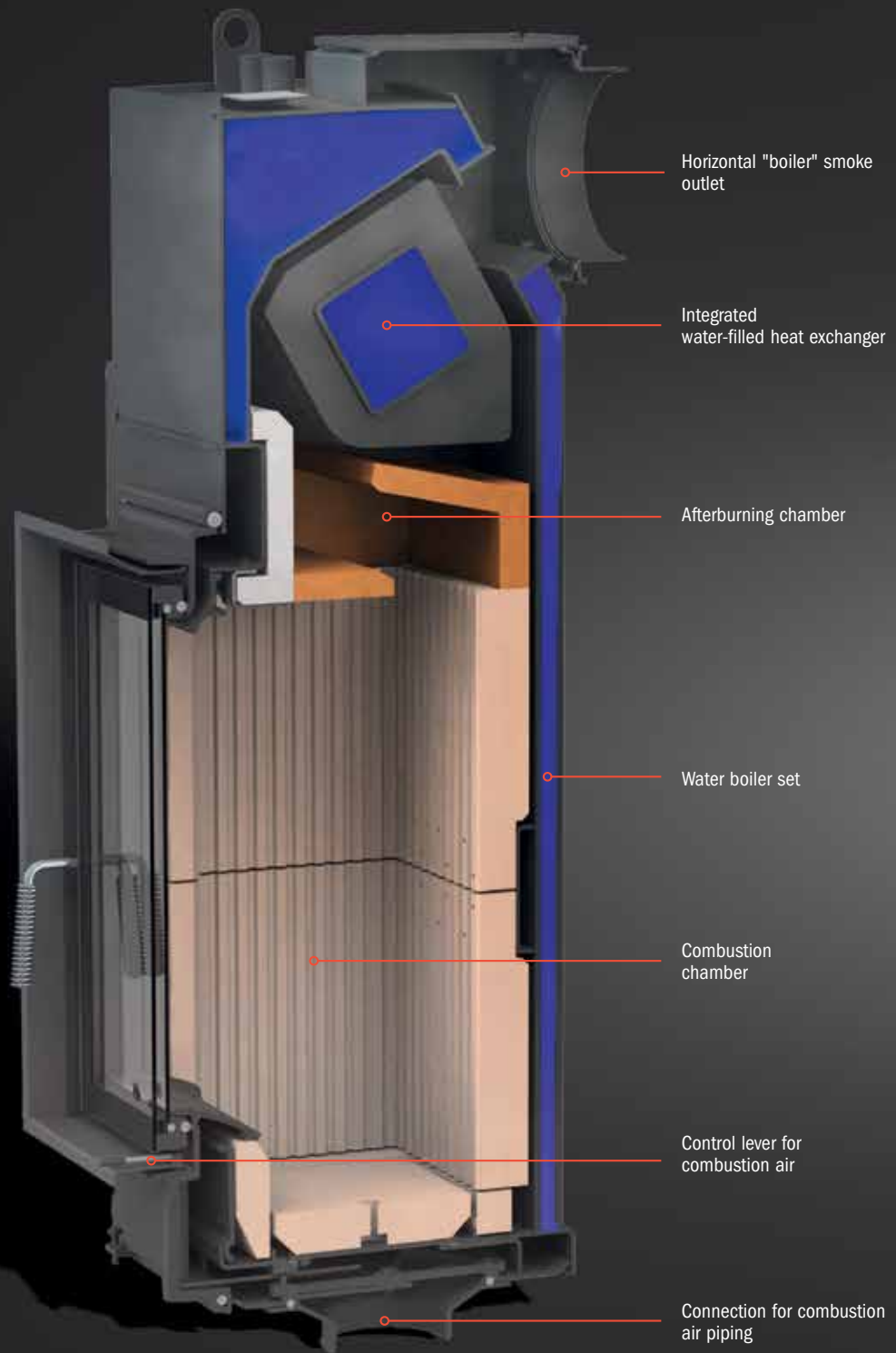

THE LIVING ROOM BOILER
HKD 2.2 K SK

THE PRINCIPLE OF *Kompakt-Kessel*

THE ALTERNATIVE - TILED STOVE WITH BOILER SHARE

Heating insert, boiler case and ceramic storage mass on smallest floor area. We have deliberately avoided combustion gas flaps and big switchable heat exchangers, which are typical for the "SK" boilers.

The compact boiler dimensions allow for space-saving stove design with a fixed water heating share.

WITH SMALL STORAGE MASS AND MEDIUM BOILER POWER

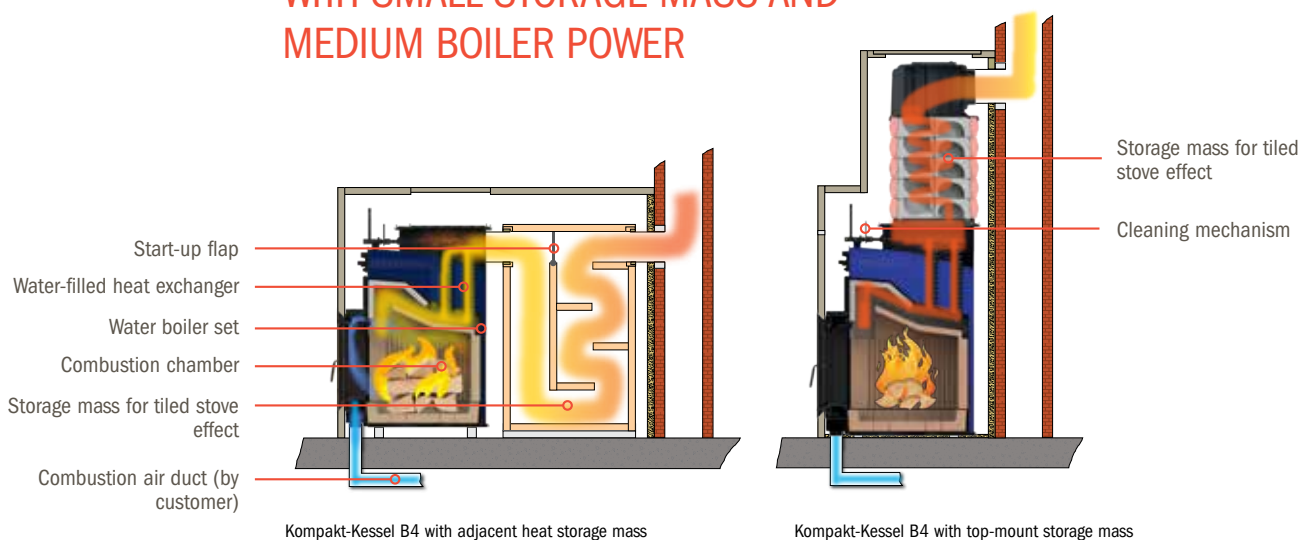

WITH BIG STORAGE MASS AND SMALL BOILER POWER

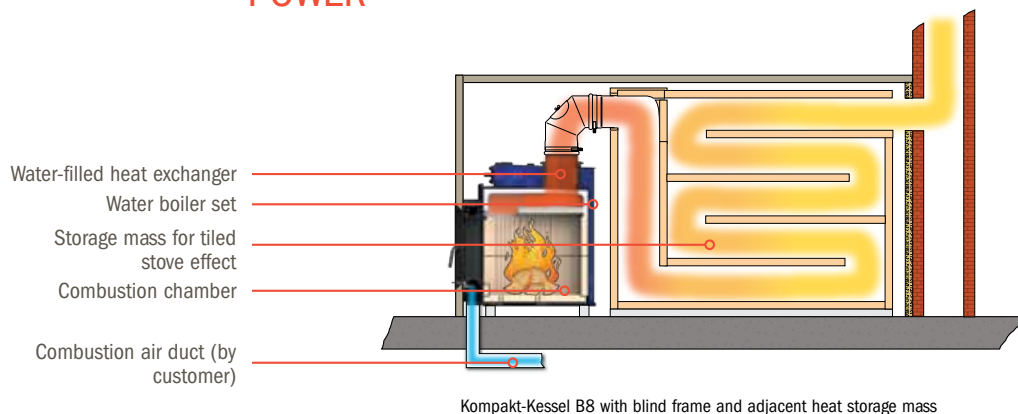



Water-bearing tiled stove
Kompakt-Kessel B4
Tiles: Sommerhuber

THE KOMPAKT-KESSEL FOR *small* STORAGE MASSES

The heat exchanger surface in contact with combustion gas is deliberately smaller as in the SK boilers. Afterwards the combustion gases have yet sufficient energy to warm up a small storage mass. The storage mass for tiled stove effect is mounted on top or arranged next to the firebox.

With the comfortable cleaning mechanism, the periodic heat exchanger cleaning is much easier and faster to complete.



B4
with door frame

Wood capacity: 5 - 10 kg
Log length: 50 cm
for tiled stoves with storage mass up to 250 kg

Allocation of available heat

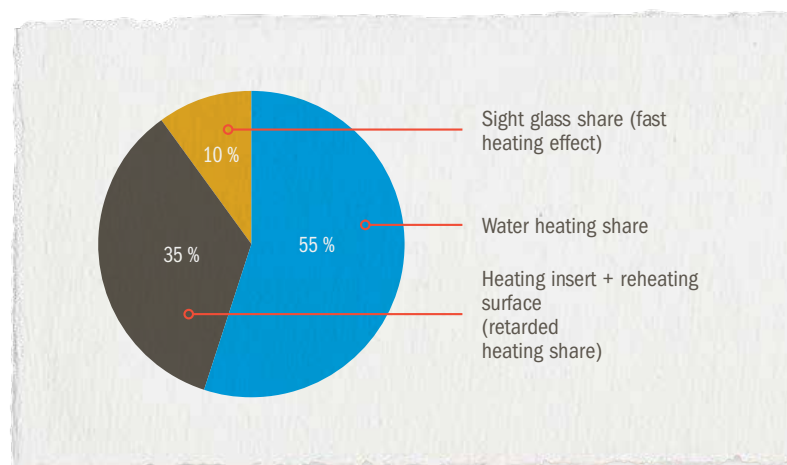

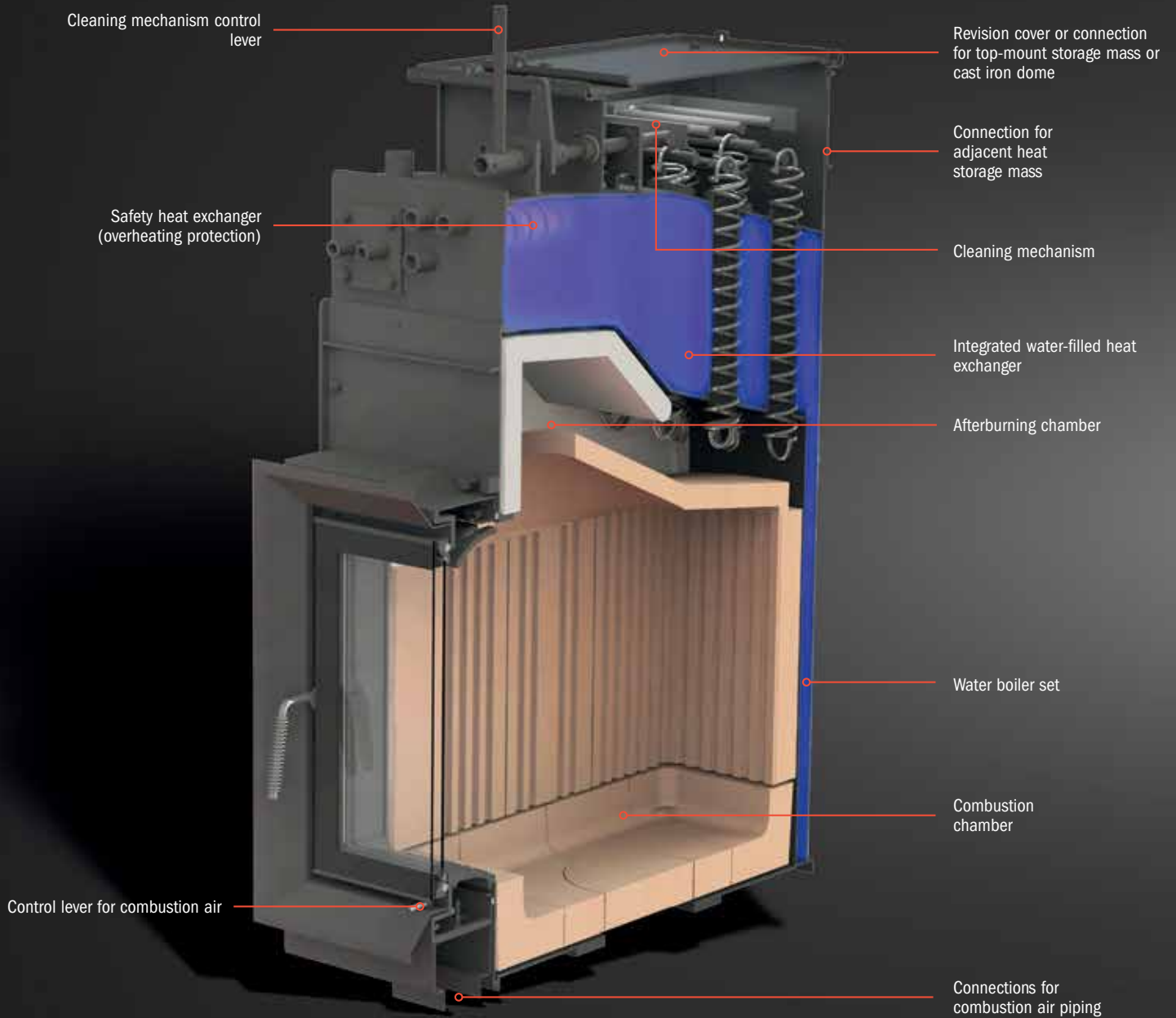

KOMPAKT-KESSEL B4 WITH CLEANING MECHANISM

THE KOMPAKT-KESSEL FOR *big* STORAGE MASSES

The classic wood burner with water jacket. One third of the usable heat amount is supplied to the heating system. The remaining energy of the still high combustion gas temperatures goes in typical tiled stove reheating surfaces. This can be metallic reheating devices for warm air convection or ceramic ducts for long-lasting heat radiation.

Due to dimensions of boiler case and the cast iron or steel front, the B7 and B8 models are perfectly suitable for replacing old inserts in existing tiled stoves. This way it is possible to upgrade an existing accumulation stove in a short time, by adding water heating functionality at reasonable cost.



B7
with door frame

Wood capacity: 3 - 6 kg
Log length: 33 cm
for tiled stoves with storage mass
up to 400 kg



B8
with cast iron front

Wood capacity: 4 - 8 kg
Log length: 50 cm
for tiled stoves with storage mass
up to 600 kg

Allocation of available heat

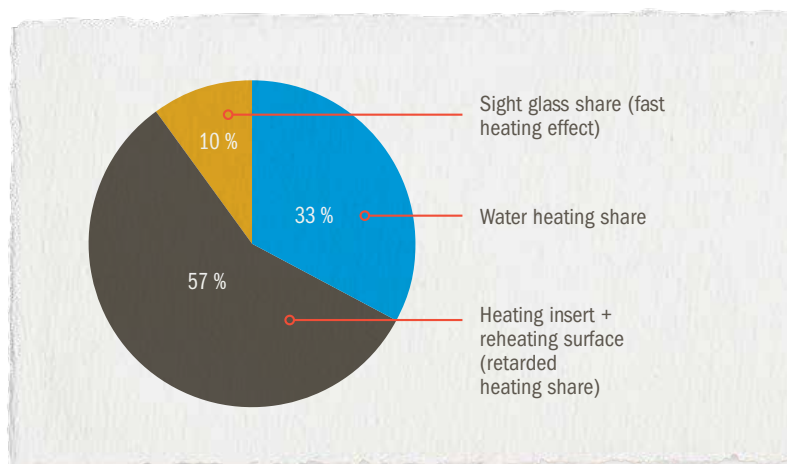



**KOMPAKT-KESSEL B8
WITH DOOR FRAME**



The heating system at a glance:
water-bearing tiled stove with HKD 2.2 XL-SK/h Tunnel, EOS combustion control
and BHZ heating center.

COMFORT OF USE: STOVE *control*



The EOS Touchdisplay (17 x 17 cm) is available in two colors: with white or black glass panel.

A WOOD FIRING DEVICE IS JUST AS GOOD AS THE WOOD ITSELF AND PROPER OPERATION.

Therefore, especially in the case of water-bearing stoves it is important and reasonable to install the electronic stove control system (EOS). Apart from the automatic combustion air adjustment with highest efficiency, it comes with a great comfort of use. Load some wood and light the fire, everything else will be adjusted with the combustion air controller by itself.

Especially clearly arranged is the presentation of current status of buffer tank and heating system. The touch-sensitive display under a glass panel is self-explanatory and shows how heat is produced, stored and consumed.



The mybrunner app - the online access to your heating system.

THE *planning*

THE WATER-BEARING FIREPLACE OR STOVE INSERT SUPPORTS THE CENTRAL HEATING.

While planning, it is most important to align the production and distribution of heat with the specific heating load of a building.

This is how heating power is created:

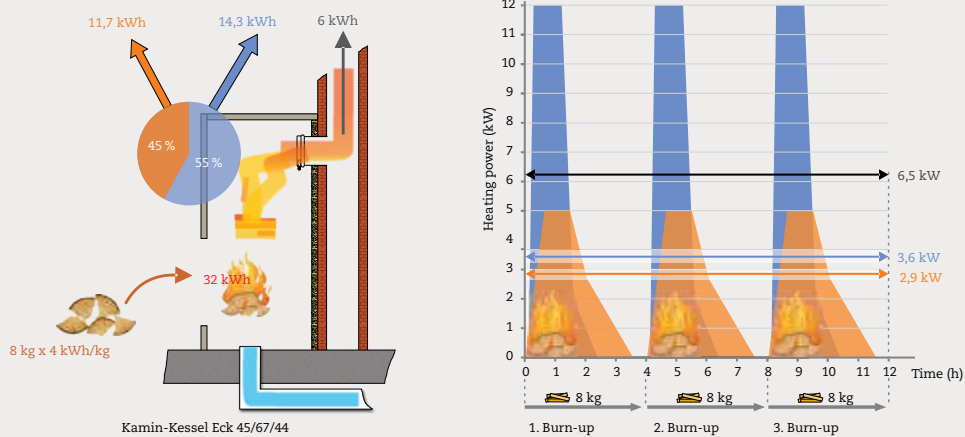

Heating power depends on actual load of firewood and heating intervals. For example, if 8 kg of wood is loaded every four hours, the average heating power is 6.5 kW (ref. graphics).

HEATING LOAD AND WOOD CONSUMPTION

Only when the heat demand of a building is known, it is possible to tell the required amount of wood. Heating load calculations according to EN 12831 are provided by engineering and planning offices, and such services are also offered in the Internet. Heating load is determined for extremely low outdoor temperatures (-12 °C to -16 °C). During normal winter days, demand is around 30 - 50 % below design case value (see "Daily wood consumption" chart).

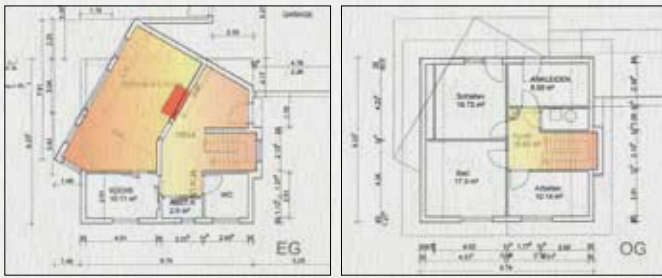

The most suitable water heater is selected according to the required heat shares. In this example, the living spaces to be heated by direct heat transfer are marked with a colour (here: approx. 48 % of the living space). In this case, the perfect water heater should have a boiler share of approx. 50 % or more.

THE HEAT SOURCE

Besides the wish to have a tiled stove or fireplace functionality, the choice of the right boiler type plays the most important role. The main criteria include the available water heating or boiler shares of a heating device - the power specifications are only secondary references. The boiler share and radiation share of a heating insert should possibly conform to distribution of heat demand in a building. Too much heat will lead to a "steam bath" effect.

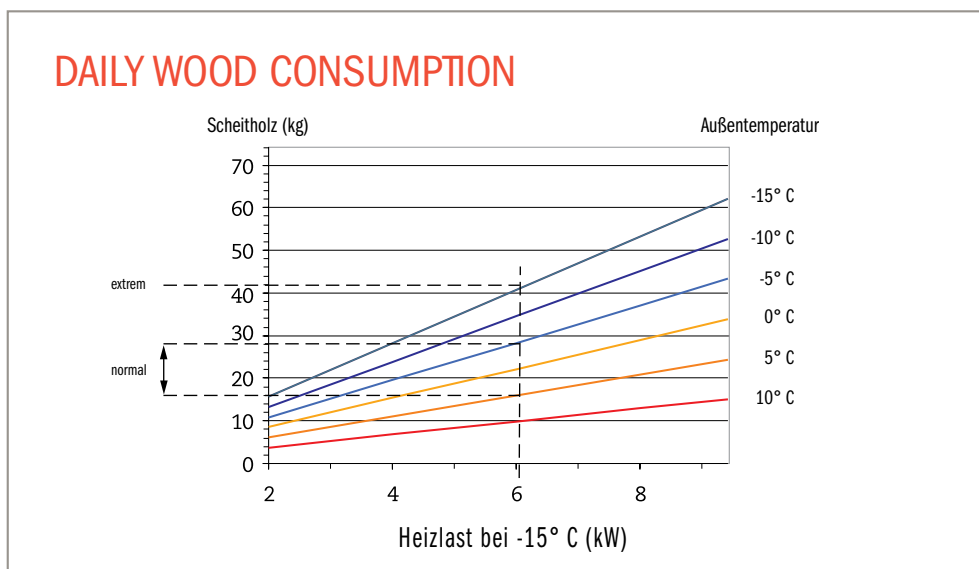

Safety

The safe operation of a water-bearing stove requires always a sufficient level of chimney negative pressure. When the fire is lit, the negative pressure safety device (the "USA" switch) checks, if there is enough negative pressure for safe evacuation of combustion gases. If a kitchen hood or a defective air conditioning system is working against the chimney effect, the USA switches off the corresponding disruptive factor due to safety reasons. Otherwise, it would be possible that the gases will be released into the room.

The monitoring unit will be activated as soon as the fire is lit. When the stove or fireplace is cold, the system is in standby mode.

Negative pressure safety device USA 4 with glass front.
Behind the detachable glass plate (12 x 12 cm) there is a line display with control elements.
A specialized technician can use them to recall the current negative pressure value and data about commissioning and function check. The USA switch is officially approved as a safety device by German building inspection authorities (DIBt approval no.: Z-85.1-8).



Radio transmitter

The version with built-in radio transmitter and corresponding receiver components can be used for wireless connection with the air conditioning systems.



Water-bearing fireplace
Architektur-Kamin 38/86 with top-mount boiler

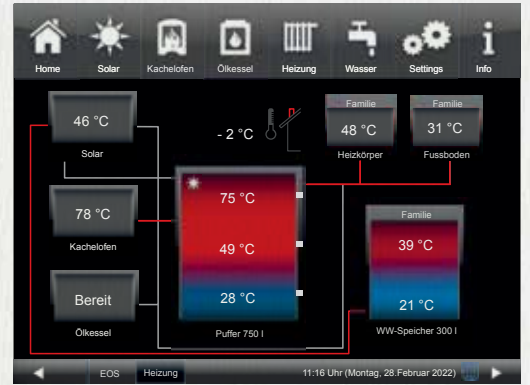

On the Touchdisplay of the EOS electronic control system it is possible to control the functionality of existing or simple heating systems. Supplementary heating functions are integrated with the control system via BRUNNER extension boards.

Water-bearing fireplace
Stil-Kamin 51/67 with top-mount boiler

THE STANDARD SOLUTION

Hydraulic CONNECTION WITH HEATING SYSTEMS

From a technical point of view, integration with existing heating system has two basic requirements:

- ▷ **installed pump unit with return flow increasing device**
- ▷ **a sufficient heating water tank**

The heating water output levels during combustion are mostly far beyond the current needs of a heating system. A buffer tank is used to compensate this.

It collects and holds the surplus heat, and makes it available between combustion cycles. Depending on demand, it is necessary to heat up again after 3 - 8 hours. The buffer tank has usually a volume of 500 - 1000 litres. Greater volumes are unreasonable in most cases, because the bigger tank width results in faster equalization of different temperature levels than with a "slim-waisted" tank.

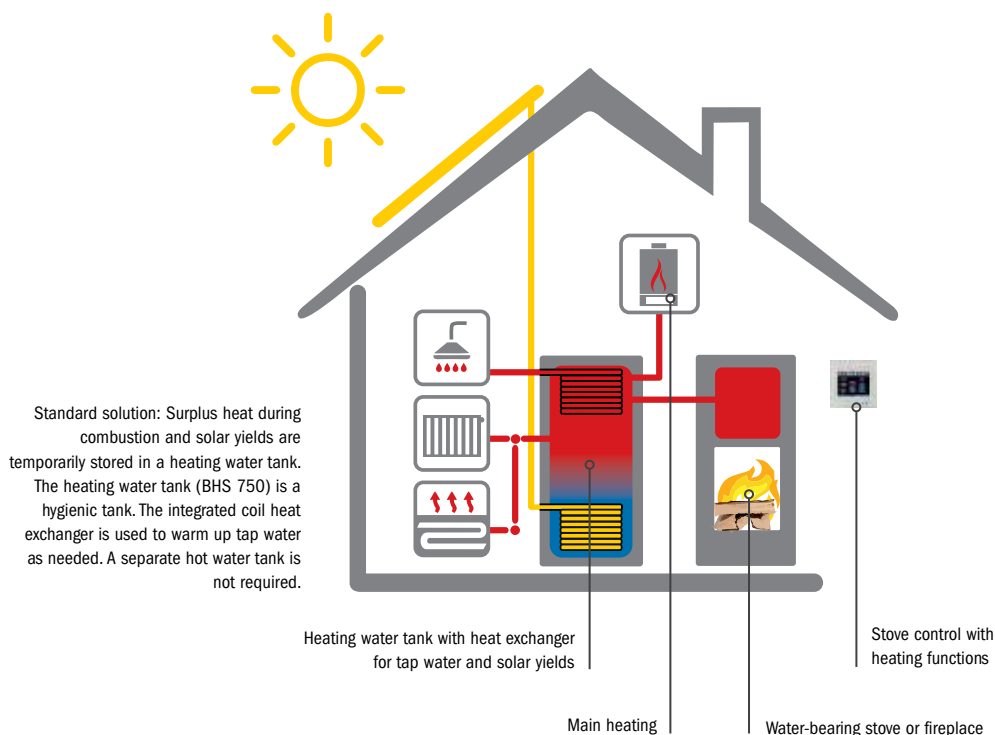

THE COMFORTABLE SOLUTION

BRUNNER *Heating Center*

HYDRAULICS AND CONTROLS NETWORKED INTO A SYSTEMIC SOLUTION.

The BRUNNER Heating Center is a complete, preassembled, turn-key heating and heat storage system. It is designed for the connection and management of multiple heat sources of different types, especially for the integration of water-bearing stoves and fireplaces.

The eco-hierarchic operation principle is adapted to the application of renewable heating sources. The hydraulic and control system components have been optimized by us over the previous 25 years.

Whether for new systems or heating system modernization with existing components (e.g. hot water boiler, oil heater), the Heating Center integrates all heating sources with building systems and optimizes the interplay between the heat sources, heat collection and heat distribution.

THE DISPLAY UNIT.

When a heating system is built with the BRUNNER Heating Center (BHZ) the operating interface for the stove system (EOS) is combined with the BHZ display unit. A third, additional display unit can be installed in the living area. The heating system overview is available in every desired location at home.

THE ENTIRE HEATING SYSTEM AT A GLANCE.

All tiled stove and heating functions are available on the same Touchdisplay. In addition, we pay extra attention to user-friendly operation.



Touchdisplay with Home View of the BHZ Heating Center

By touching the individual text or graphic fields you can find more details for the provided functions and information.

BRUNNER Heating Center

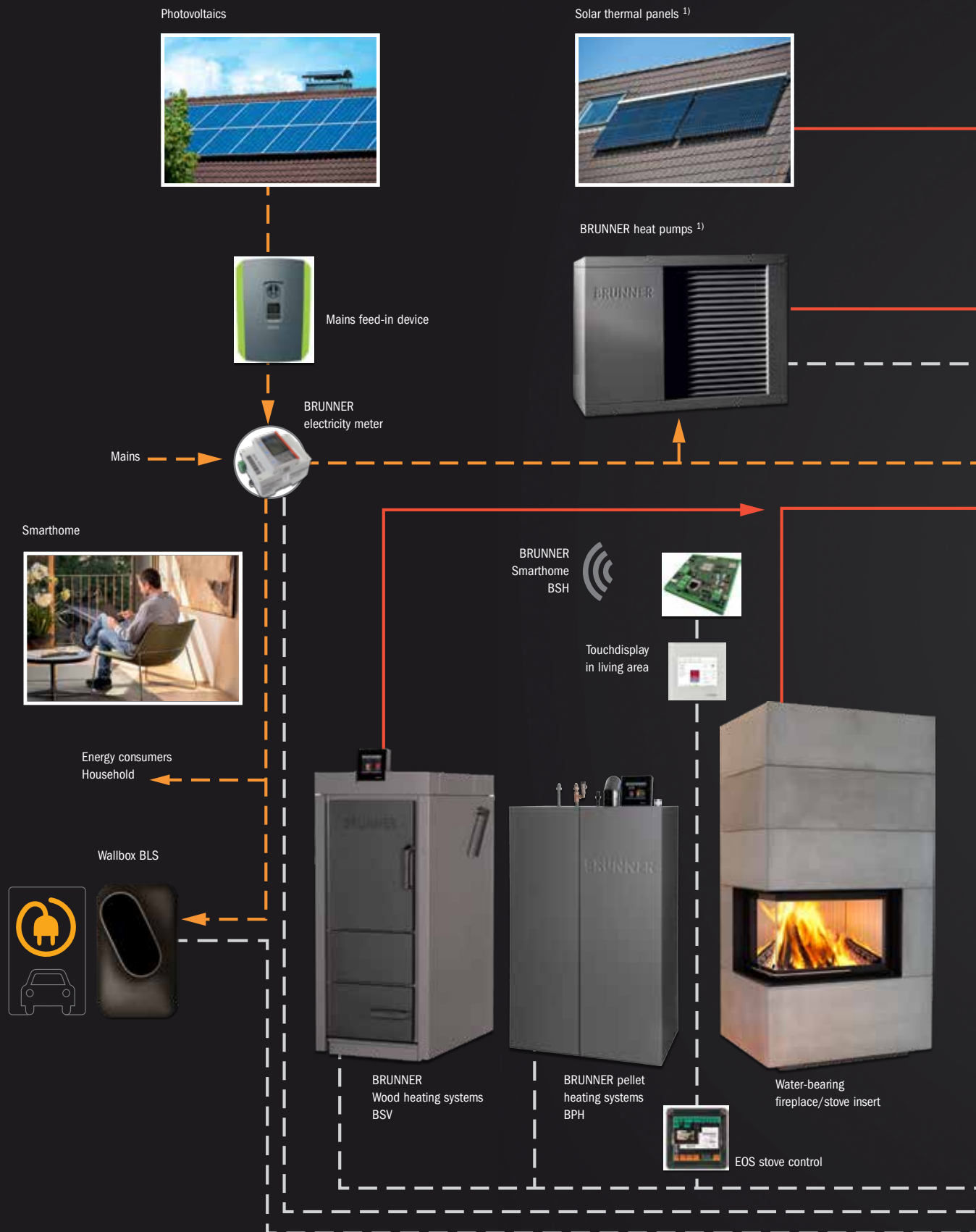

¹⁾ Connection for heat pump or connections for solar thermal energy are shown schematically

THE ECO-HIERARCHIC OPERATION PRINCIPLE IS ADAPTED TO THE APPLICATION OF RENEWABLE HEATING SOURCES.

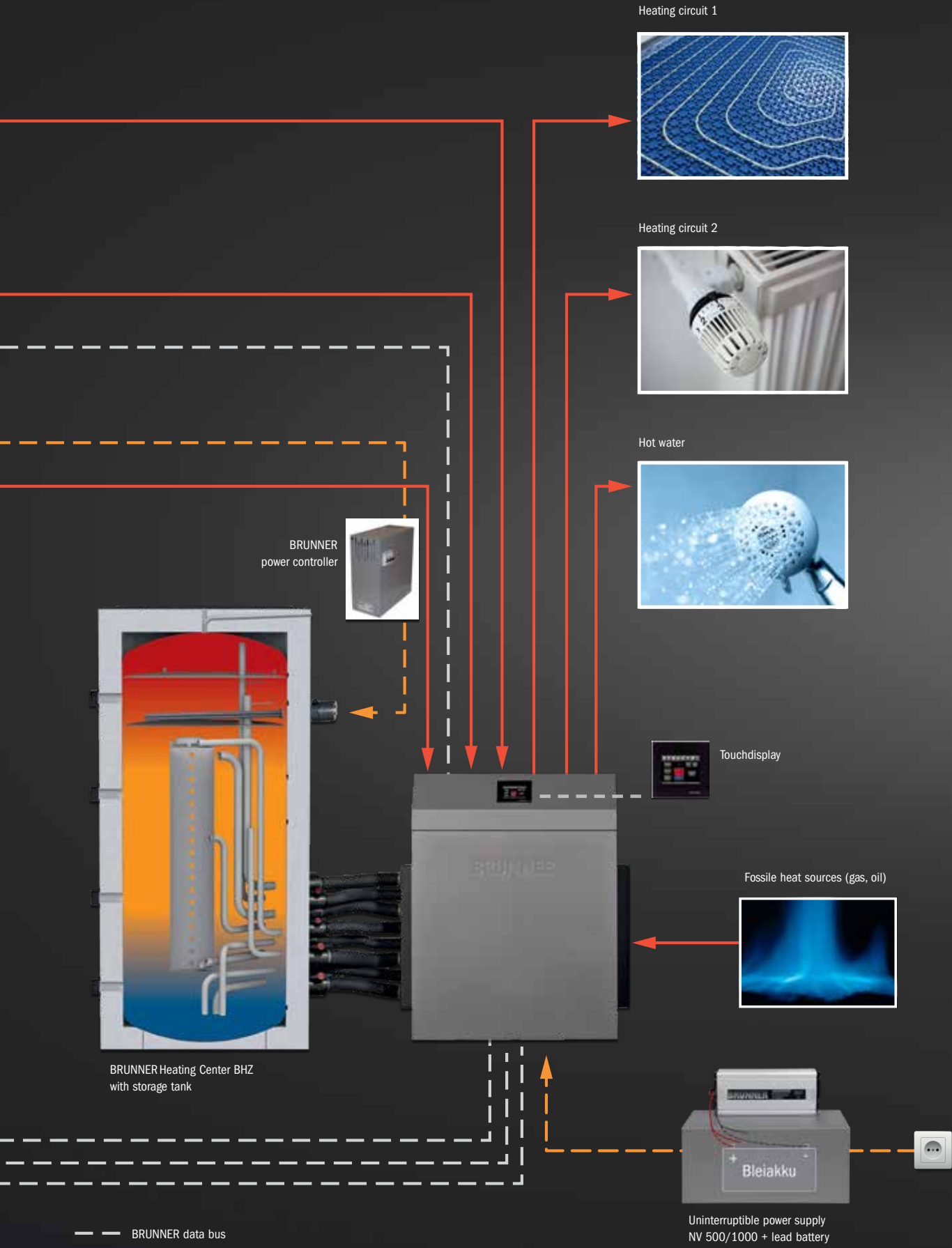

**A REASONABLE HEATING CONCEPT
CANNOT BE BETTER!**



Family home with
BRUNNER heat pump & stove system
BRUNNER air-water heat pump BWP 9 green

Heat PUMP & STOVE SYSTEM

WOOD-BASED HEATING SAVES ELECTRICAL ENERGY AND RELIEVES THE HEAT PUMP.

When outdoor temperatures are falling, the efficiency of air-water pumps decreases. Especially then it makes not only fun, but also sense to bet on wood heating. A wood heater is more than just a stove or fireplace. Your added value for the heating system is the integrated boiler, which is used for heating water.

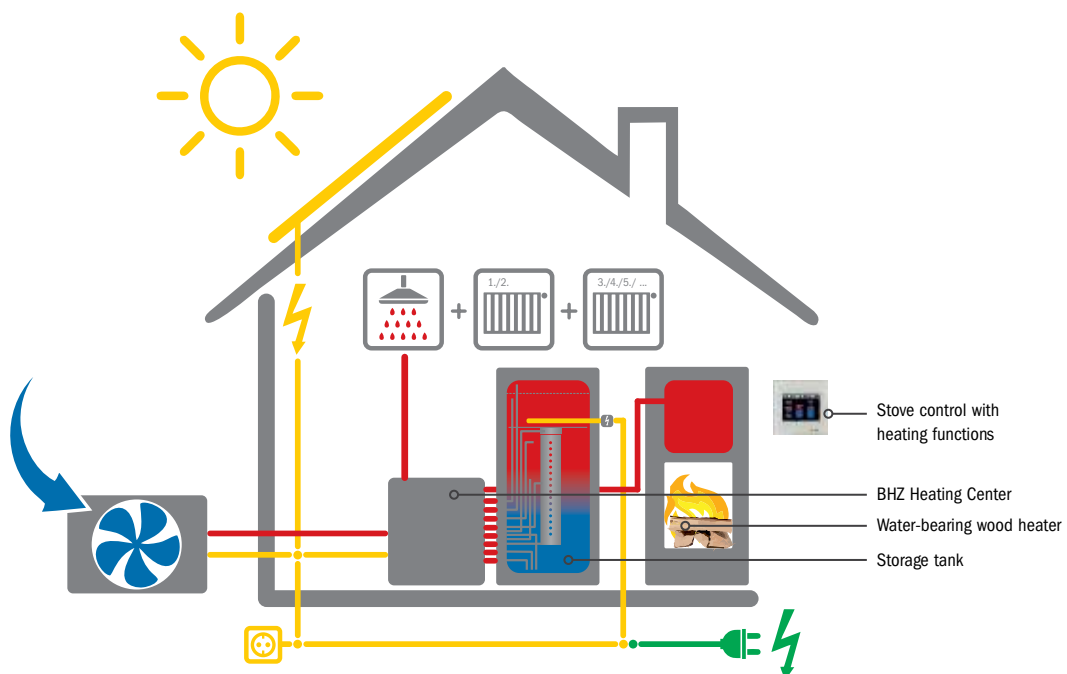

The comfortable solution: BRUNNER heat pump and water-bearing wood heater with BHZ Heating Center and additional integration with solar power.

WOOD FIRES - THE LIFETIME EXTENDERS.

Water pumps are generally always able to ensure the required temperature level. But on frosty days, the pure "heat pump effect" is not sufficient. Additional electrical energy is required. The heating concept will be perfect, when in this situation a water-bearing wood heater is used. This provides atmosphere, saves energy, relieves the heat pump and extends its lifetime.

The VARIANTS

WATER-BEARING WOOD COMBUSTION INSERTS

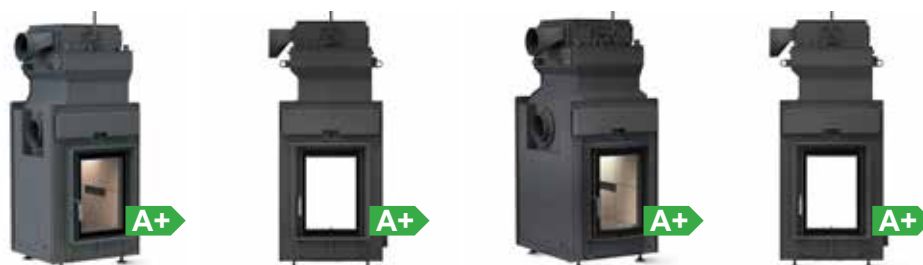

	HKD 2.2 SK 30-70 %	HKD 2,2 SK Tunnel 30-70 %	HKD 2.2 XL-SK/h 25-70 %	HKD 2.2 XL-SK/h Tunnel 25-65 %
--	-----------------------	------------------------------	----------------------------	-----------------------------------



	HKD 2.2k SK f 65-70 %	HKD 2.2k SK r 65-70 %	HKD 2.6k SK 65-70 %	
--	--------------------------	--------------------------	------------------------	--

WATER-BEARING FIREPLACES

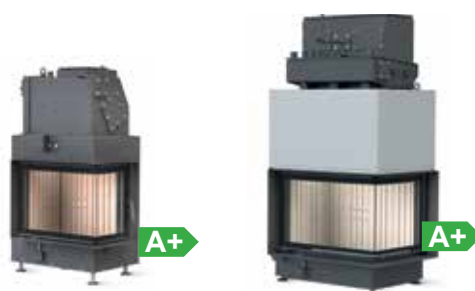

Left/right corner variants available

	Kamin-Kessel Eck 42/57/30 l 55%	Kamin-Kessel Eck 45/67/44 l 55%	
--	---------------------------------------	---------------------------------------	--

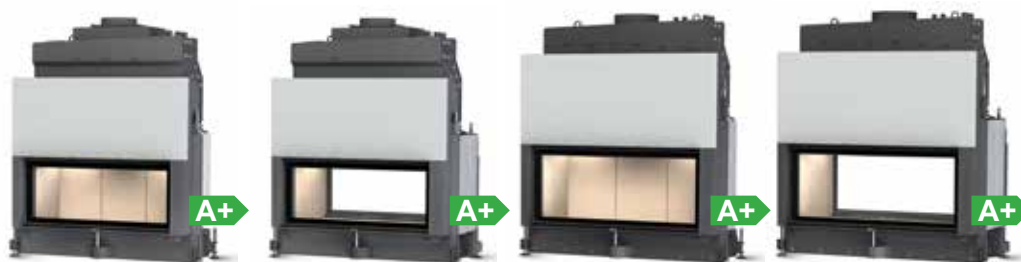

	Architektur-Kamin 38/86 with top-mount boiler 50%	Architektur-Kamin 38/86 Tunnel with top-mount boiler 50%	Architektur-Kamin 45/101 with top-mount boiler 55%	Architektur-Kamin 45/101 Tunnel with top-mount boiler 55%
--	---	--	--	---

INTEGRATED CLEANING MECHANISM

for: B4, HKD 2.2 SK, HKD 2.2 XL-SK/h, HKD 7 SK and Kamin-Kessel Eck 45/67/44.



HKD 2.2 SK with integrated cleaning mechanism



HKD 7 SK
40-60 %

HKD 7 SK Tunnel
40-60 %



B4
55%

B7
33%

B8
33%

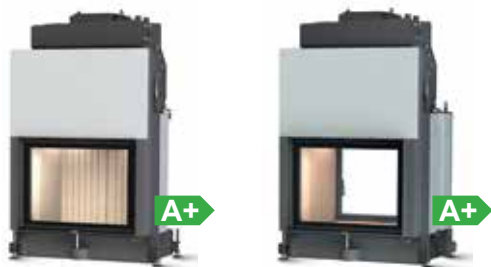

Stil-Kamin 51/67
with top-mount boiler
45%

Stil-Kamin Tunnel 51/67
with top-mount boiler
45%

Water heating share in blue
For technical data and dimensions,
go to Products and Downloads sections on www.brunner.eu
Type names of water-bearing fireplaces:
door height/width dimensions in cm
k (short): with reduced combustion chamber depth

Let's make it clear:

Water-bearing tiled stoves and fireplaces are lifetime companions. Because we know what it means, the components of BRUNNER heating devices comply to the highest quality standards. Even the comparatively high weight of our products reflects our motto:

»Only the best is good enough for your water-bearing fireplace or tiled stove.«

Therefore, insist on genuine BRUNNER.

We guarantee with our good name for every piece of our stove components.

Eggenfelden, June 2023

H. Brunner

Hubertus Brunner



The good wood & pellet boilers by BRUNNER.

heizen auf bayerisch.

Ulrich Brunner GmbH

Zellhuber Ring 17-18

D-84307 Eggenfelden

Phone: +49 8721-771-0

info@brunner.de · www.brunner.com

BRUNNER products are offered and sold only by qualified dealers and service centres. Subject to technical and assortment changes. Errors excepted. All depicted items can include additional functions or optional features available at extra cost. Reprinting and reproduction, including excerpts, only with the express permission of the publisher.

Status 06/2023 · Ver. 2.2 · 5 K · BRU1900 · atwerb.de

The paper used in this brochure is manufactured with pulp from sustainable forestry and other controlled sources. Printed with organic inks based on renewable raw materials.



Water-bearing tiled stove
The "living-room boiler" HKD 2.2 XL-SK/h Tunnel
Design: Ofenhaus Dörfler

BRUNNER®



Klimaneutral
Druckprodukt
ClimatePartner.com/53093-2305-1010