























N18

Datenblatt



Abbildung: N18 | Naturstein: Crema Marfil

Standard	Gesamtgewicht	Optional	Zubehör	Naturstein	Kamineinsatz
 Front Anthrazit	 ca. 370 kg		 Heizwasser-Aufsatzregister R	 Aufsatzspeicher	 Pano 5557 h NW-Leistung: 7 kW Abgasstutzen: Ø 180 mm  Energieeffizienzklasse nach (EU) 2015/1186 für Kamineinsatz Mehr Infos unter www.camina-schmid.de
 Tür hochschiebbar			 Warmluft-Aufsatzregister	 Außenbefuerung	
			 SMR	 Vorlegeplatte	
			 Blanco Carrara	 Blanco Macael	
			 Blanco Nacarado	 Caliza Moka	
			 Crema Marfil	 Marron Emperador	
			 Travertino Romano	 Negro Abanilla	
			 Rojo Alicante	 Rosa Claro	
			 Rosa Crema		
			Weitere Natursteinausführungen auf Anfrage erhältlich.		

N18

Maßzeichnung

Frontansicht M 1:25

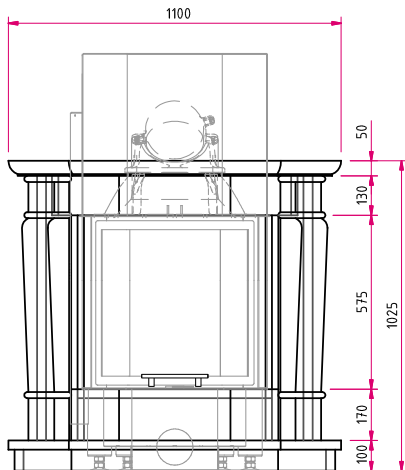

Seitenansicht M 1:25

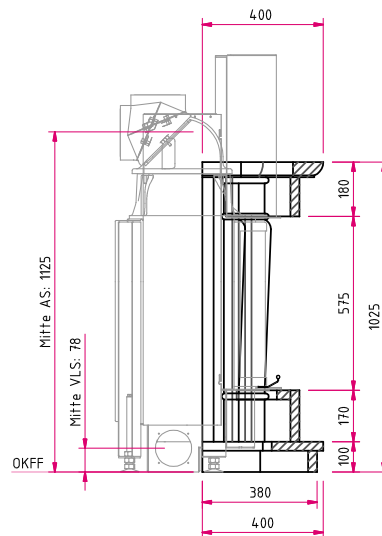

Draufsicht M 1:25

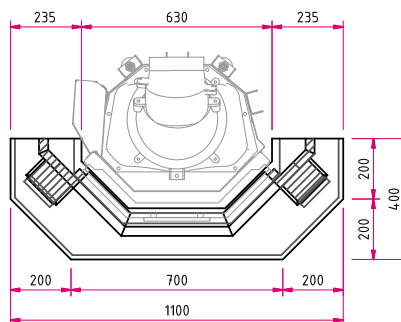

Hinweis Seitenansicht M 1:25: AS: Abgasstutzen, VLS: Verbrennungsluftstutzen, OKFF: Oberkante Fertigfußboden

Bitte beachten Sie die Angaben für **optionales Zubehör** in unserer Preisliste.

Abbildungen ähnlich. Alle Abbildungen und Zeichnungen sind urheberrechtlich geschützt. Verwertung oder Veröffentlichung, auch einzelner Details, nur mit unserer Genehmigung. Farbliche und technische Änderungen durch Weiterentwicklungen sowie Irrtümer vorbehalten. Stand: 07/2018