

























N9

Datenblatt



Abbildung: N9 | Naturstein (zweifarbzig): Caliza Moka mit Negro Abanilla

Standard	Gesamtgewicht	Optional	Zubehör	Naturstein	Kamineinsatz
 <p>Front Kristall</p>  <p>Tür schwenkbar Anschlag li./re.</p>	 <p>ca. 420 kg</p>	 <p>Tür hochschiebbar</p>  <p>Doppelverglasung</p>  <p>Tunnelversion</p>	 <p>Heizwasser-Aufsatzregister R</p>  <p>Aufsatzspeicher</p>  <p>Warmluft-Aufsatzregister</p>  <p>Außenbefuerung</p>  <p>SMR</p>  <p>Vorlegeplatte</p>	 <p><i>Blanco Carrara</i></p>  <p><i>Blanco Macael</i></p>  <p><i>Blanco Nacarado</i></p>  <p><i>Caliza Moka</i></p>  <p><i>Crema Marfil</i></p>  <p><i>Marron Emperador</i></p>  <p><i>Travertino Romano</i></p>  <p><i>Negro Abanilla</i></p>  <p><i>Rojo Alicante</i></p>  <p><i>Rosa Claro</i></p>  <p><i>Rosa Crema</i></p> <p>Weitere Natursteinausführungen auf Anfrage erhältlich.</p>	 <p>Lina 5557 s NW-Leistung: 7 kW Abgasstutzen: Ø 180 mm</p>  <p>Energieeffizienzklasse nach (EU) 2015/1186 für Kamineinsatz</p> <p>Mehr Infos unter www.camina-schmid.de</p>

N9

Maßzeichnung

Frontansicht M 1:25

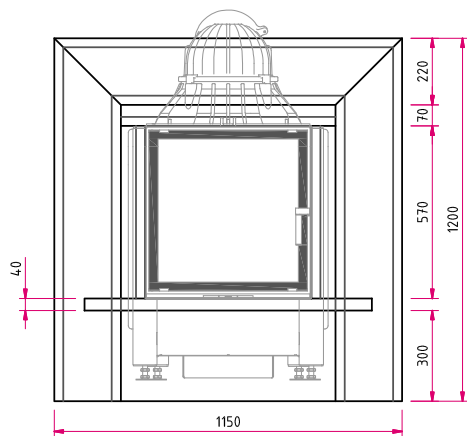

Seitenansicht M 1:25

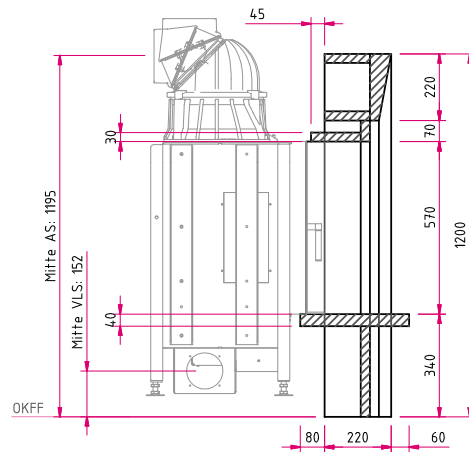

Draufsicht M 1:25

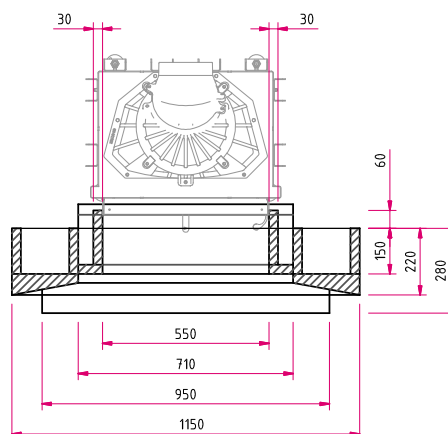

Hinweis Seitenansicht M 1:25: AS: Abgasstutzen, VLS: Verbrennungsluftstutzen, OKFF: Oberkante Fertigfußboden

Bitte beachten Sie die Angaben für **optionales Zubehör** in unserer Preisliste.

Abbildungen ähnlich. Alle Abbildungen und Zeichnungen sind urheberrechtlich geschützt. Verwertung oder Veröffentlichung, auch einzelner Details, nur mit unserer Genehmigung. Farbliche und technische Änderungen durch Weiterentwicklungen sowie Irrtümer vorbehalten. Stand: 07/2018